

Frascati, March 4, 2007

Note: **CD-15**

UPGRADE OF THE DAΦNE DIAGNOSTIC FLUORESCENT FLAGS SYSTEM

B. Buonomo, O. Coiro, C. Mencarelli, D. Pellegrini

Introduction

A system of 23 fluorescent flags in DAΦNE allows to acquire through low-cost CCD cameras the position and dimensions of the beam along the transfer lines (fig. 1) and also allows a prompt control on the efficiency of the injection of the electrons and positrons into main rings. The system, operational in the last ten years has been widely used in the preliminary operations of the commissioning of the DAΦNE complex, and is still used daily as a principal diagnostic system.

The main problem of this system was caused by the short life-time of the CCD cameras due to the damaging produced from the radiations. In particular positions of the transfer lines (hodoscopes, BTF, DHPTT001, injection-extraction Accumulator), the amount of radiation produced an immediate damage of the CCD camera that made impossible the observation of these flags.

In this note we will describe in detail the flag system and the upgrade carried out during the shutdown in 2006, that allowed to increase the life time of the CCD in the aforesaid critical positions. This was achieved by planning and installing new optical systems with a shielding around the CCD camera, by means of which it was possible to decrease the damage caused by radiations.

Description of the system

As material for the flag a beryllium oxide was chosen, this material offers a strong resistance to radiation induced damage, another important characteristic of this flag is the linearity in response to charged particles accelerated in a wide range of energy.

The dimensions of the flags are 50x50 mm (25x25 mm for the injection septa), they have markers in order to define the position of the beam (fig. 2 and 3); besides the injection/extraction septa of the accumulator and of the main Rings, the horizontal markers are drawn to compensate the position of the flag, that are positioned at an angle of 45 degrees respect to the longitudinal axis of the beam.

These screens are used to monitor the beam size and position, during the Transfer Lines set up, but they are not compatible with injection at full rate. A couple of them is provided in the injection/extraction septa of the Accumulator and the Main Rings.

The emitted light can be observed through a flange of transparent glass, resistant to UHV, by means of the CCD camera that are placed at 90° angle respect to the beam path.

The flags can be inserted by means of a pneumatic device, that is used to control the speed of insertion of the flag and preserve it from damage; the position of the flags (in/out) is controlled by two limit switches that delimit its stroke and, when the flag is inserted, its centre corresponds to the geometric centre of the vacuum chamber.

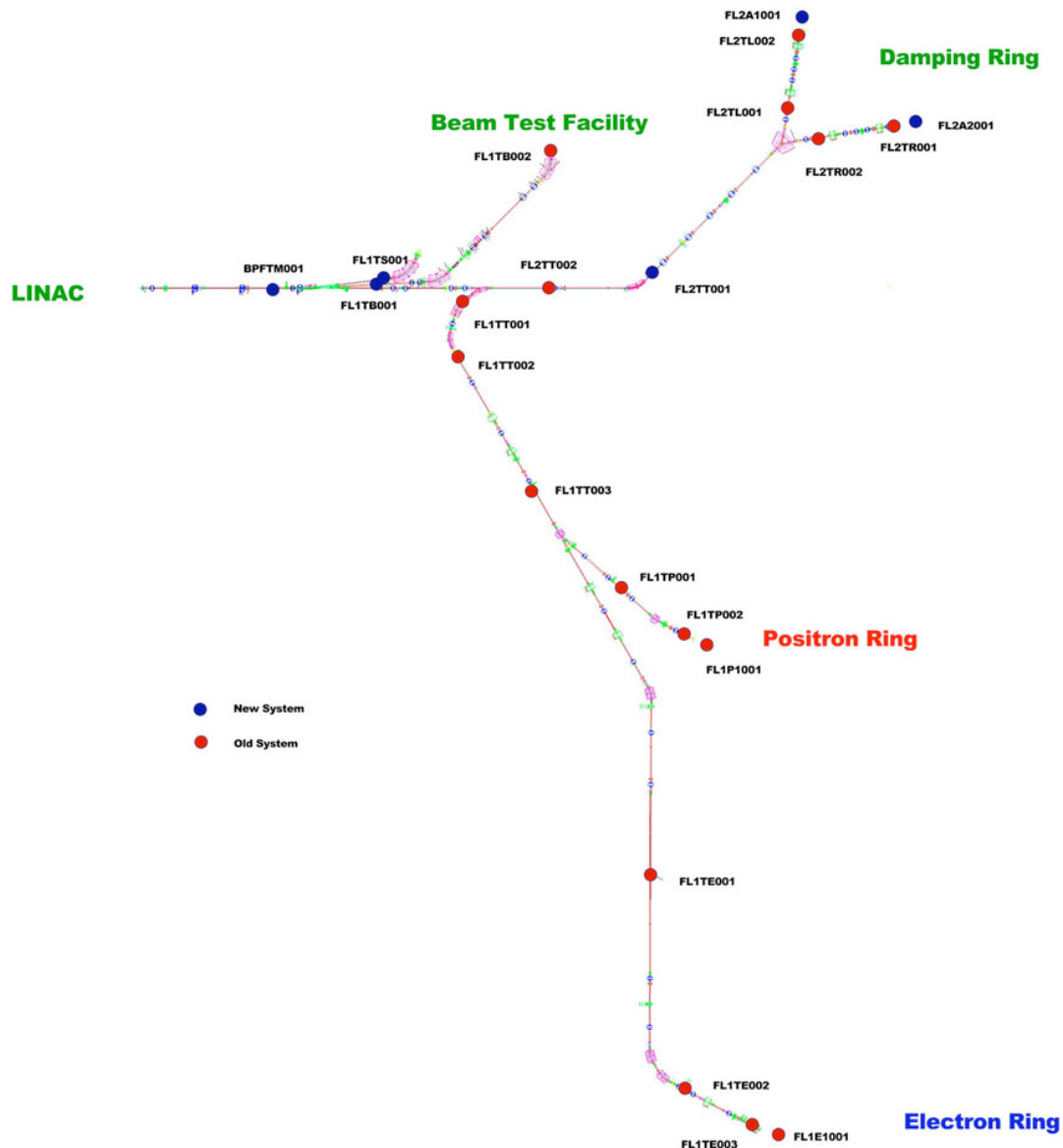

Fig. 1: Fluorescent flags position along the transfer lines.

The pneumatic devices are controlled locally or directly by the remote Control System. Originally, the cameras PHILIPS VCM62500 CCD (monochrome, standard 1/2") were used, but can no longer be found, therefore we chose CCD cameras (standard 1/3"), type PHILIPS LTC0335 or SONY M183. These CCD cameras produce images with high picture quality (380 TV lines of resolution) and have remarkable sensitivity with an S/N ratio of more than 50 dB. The choice of these CCD cameras with a.c. power supply allows the automatic synchronization with the local electric net at 50 Hz to witch the Linac and injection/extraction systems are also synchronized.

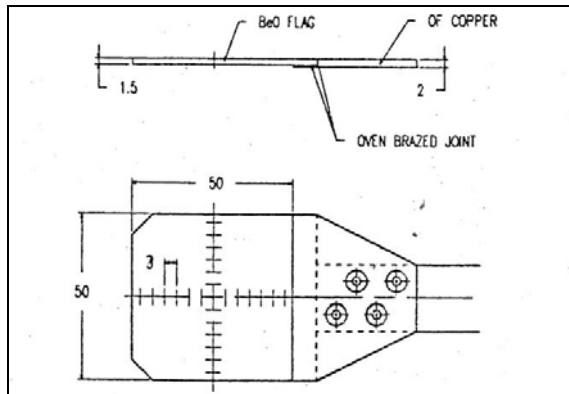

Fig. 2: Mechanical design of TL flag.

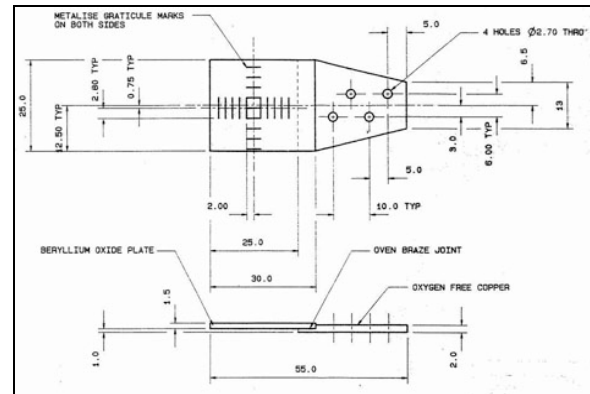

Fig. 3: Mechanical design of septa (inj/ext) flag.

The CCD cameras have been installed by means of metal supports directly mounted on the flange of the window glass. This allows to preserve the position of the CCD cameras at the centre of the window without further mechanical alignments (fig. 4). The acquired images have the same reference (right-left-high-low) respect to the beam path.

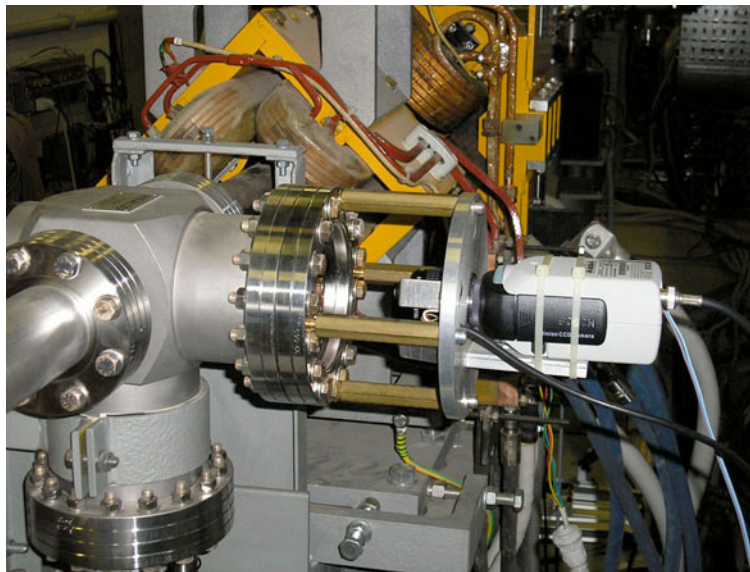

Fig.4: Example of CCD camera installed close to the fluorescent flag.

The objectives have 16 mm fixed focal length through which it is possible to see the whole flag with good deep field.

Optic filters have not been installed because in our case the intensity of the light emitted from the flag by the particles does not saturate the CCD. In order to check the system without the beam, we have mounted two high luminosity LEDs on each flange.

For the transport of the camera signal an extensive network of coaxial 75 ohm cabling, video multiplexing, video buffer and fan-out was already in place since the first installation.

The signals of the flag are selected by means of the DAΦNE Control System, where they can be seen on six dedicate monitors.

The output of the fan-out is also connected with another video multiplexer (MUX42-34001), so all the camera signals can be delivered into a graphical analyzer for detailed measurements (table 1).

Upgrade: choice of components

The effect of the radiation generated by particle beam is high in different zones along the transfer line, so the CCD cameras need to be shielded to prevent radiation damage. A simple way is to make one or more bends in the optical path so that high Z material can be placed to block the radiation generated by the flag from reaching the CCD camera.

An optical system that collects the light emitted by the flag and that transports it to the CCD cameras has been designed, realized and mounted.

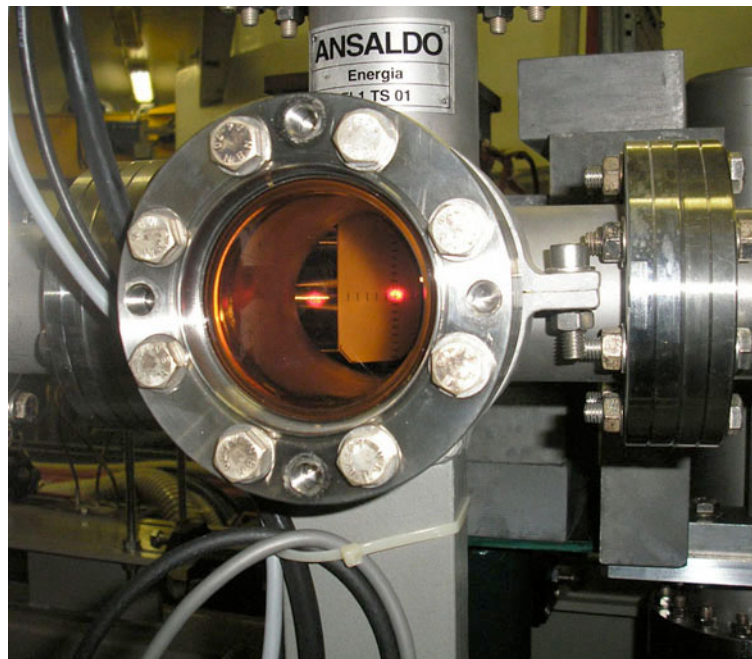

Fig. 5: Flag image inside the pipe (it is visible the laser beam used during the alignment and the darkening of the glass due to the effect of the radiations).

The system is composed of X48 and X95 series rails commercialized by the Newport [1]. They are solid pieces of aluminum, forming a rigid, yet lightweight, foundation that allows building larger precision optical systems. Rail's symmetrical cruciform cross-section provides four parallel mounting surfaces and permits carriers to be mounted to any side of it; the shape of the rails also increases their longitudinal and torsional stiffness assuring excellent stability and rigidity.

Precision dovetail design allows components to be quickly attached or removed without disturbing other carriers or components.

Each system of rails has been fixed on the floor by means of an aluminium plate (250x300x20 mm) that have three clevis pins used for mechanical alignment.

The round flat mirrors are type 01MFG030 and are produced by Melles Griot [2]. They have a diameter of 100 mm and 3 mm thickness with a surface coating of aluminium (011). These metallic coated mirrors have a very high broadband and relatively insensitive to angle incidence, with an average reflectivity greater than 90% from 400-800 nm (visible, near infrared) and a surface flatness that varies from three wavelengths over 25 mm.

They have been placed on an aluminium disc under which a mirror mount type KM200 2" (low cost mirror mount) made by ThorLabs equipped with two micrometric regulations has been attached. This allows a fine optical alignment [3].

The structures thus composed have been mounted on the carriers by means of mechanical supports that oblige the position of the mirrors to 45° respect to the two orthogonal planes of the carriers (fig. 6 and 7). The CCD cameras have been fixed on the same type of carriers with another mechanical support that allows centring the CCD cameras (image) on axis with the centre of the mirror.

In order to simplify the operations of calibration and alignment and to unify all the optics systems, AF Zoom-Nikkor 70-300 f/4-5.6 G objectives have been selected. These low cost objectives are composed of 9 groups with 13 lenses each, variable focus length (70-300 mm) and closest marked focusing distance of 1.5 m. The objectives are connecting to the CCD camera by a NIKON-C mount adapter because they are usually used with the Nikon cameras.

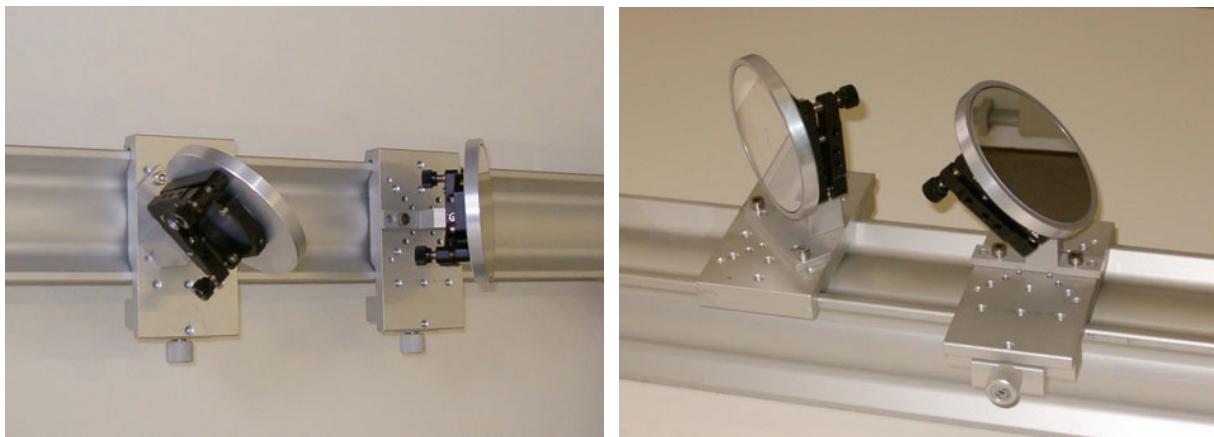

Fig. 6 and 7: Mechanical particulars of the mirrors system.

The working distance of the new optics system varies from 1.7 to 2.8m, so the selected objectives are compatible and allow for all the flags a well focused imaging with good deep field and with the necessary magnification.

The upgrade of the system can be compared in figure 8 and 9 where is shown the flag FL2A1001 that corresponds to the position of the injection (extraction) of the electrons (positrons) in the accumulator ring.

The CCD cameras have been protected with lead blocks of dimensions 20x15x10 cm; the structure thus obtained are sufficiently stable and easy removable during the maintenance operations.

Alignment and assembly

The procedure of assembly of the mechanical components has been made at the same time as optical alignment. Luminous sources (laser diode) with 635 nm of wavelength and power 4,5 mW, variable iris diaphragms and a 2" round flat mirror have been used for the optical alignment.

Once all the optical components with the exception of the CCD cameras have been mounted on the carriers and these have been positioned on the rails, a first optical adjustment could be done. To this aim, the laser has been positioned on the system in place of the CCD camera while a flat mirror has been mounted in parallel with the glass window. Moreover targets of calibration have been placed on the others mirrors and the iris diaphragms has been mounted forehead to the laser in order to obtain more collimate spot size of the light beam.

The system has been aligned by controlling that the spot light of the laser passed to the centre of all the mirrors and that light spot reflected by the flat mirrors had the same optical path of return. Then the flat mirror used to generate the total reflection of the spot light has been removed and the laser has been aligned with all the centre of the flags (fig. 5).

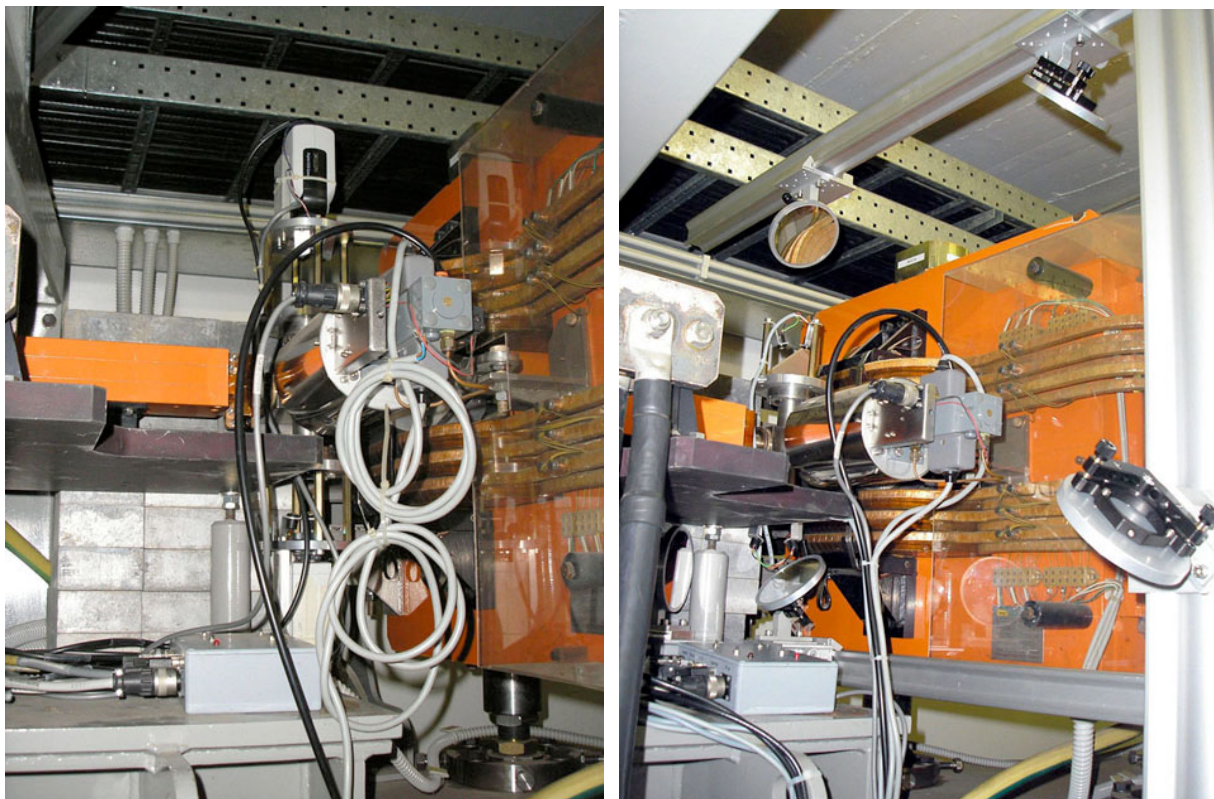

Fig. 8 and 9: Sights of a double window flag with the CCD cameras close to the vacuum chamber (left) and with the system of mirrors (right).

At this point we have fixed the base of the mechanic system to the floor, controlling simultaneously that the optical alignment did not underwent variations.

Considered the magnification of the images (the same dimensions of the flags) and the working distance of systems, the images are centred within an error of ± 1 mm.

Beam Profile Monitor (OTR)

For this particular flag, which has been already used to measure of the beam emittance of the DAΦNE LINAC [4, 5], before the implementation of the aforesaid optical system, a high resolution CCD camera has been mounted in addition to the previous ones. The CCD camera has 570 horizontal TV lines of resolution. The next measurements that will be done on this system should allow a finer resolution.

Conclusions

In order to limit the costs of the up-grade, the old system has been maintained on the flags where the radiation damage on the CCD cameras was not critical with respect to the others where the systems has been modified.

For every systems the images obtained are well focused and with good deep of field. Besides the inversion of the images introduced from the mirrors on the CCD cameras have been compensated by an appropriate design (number of mirrors) on each system to respect the same reference (right-left-high-low) of the beam path without using dedicate software.

During the first months runs of the accelerator with the new systems installed, preliminary measurements of radiation damage have been done. The result indicate that the intensity of the radiation impinging on CCD cameras measured on the new positions has been reduced by factor 10 respect the old positions.

Acknowledgements

The authors would like to acknowledge F. Ronci for the design of the mechanical supports.

References

[1] - <http://www.newport.com>.

[2] - <http://www.mellesgriot.com>.

[3] - <http://www.thorlabs.com>.

[4] - F. Sannibale: "DAΦNE-Linac Beams Emittance Measurements Design", DAΦNE Technical Note - LC-5, 3/9/1992.

[5] - G. Benedetti, B. Buonomo, D. Filippetto: "Emittance Measurement of the DAΦNE LINAC Electron Beam", DAΦNE Technical Note - LC-6, 30/11/2005.

Table 1: Connections of video signals.

